

1

2

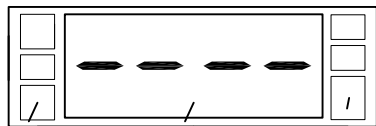

3

4

Fig.1

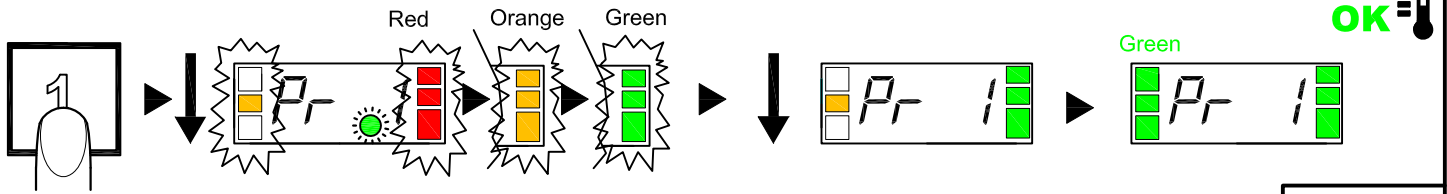
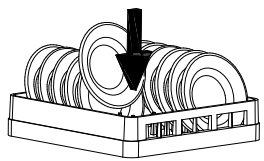
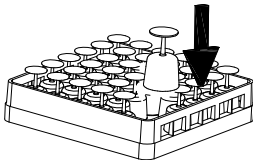

Fig.2



OK



OK

Fig.3

Fig.4

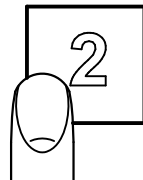

Gr EE

STEE

SAAn

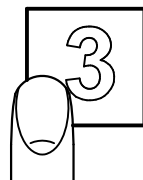

Pr 1

Pr 2

Pr 3

4



OK

Fig.5

5s

4

AS

Fig.6

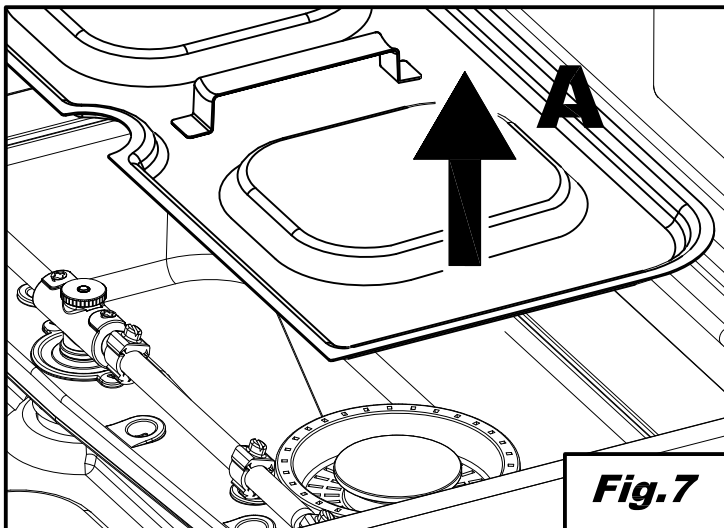

Fig.7

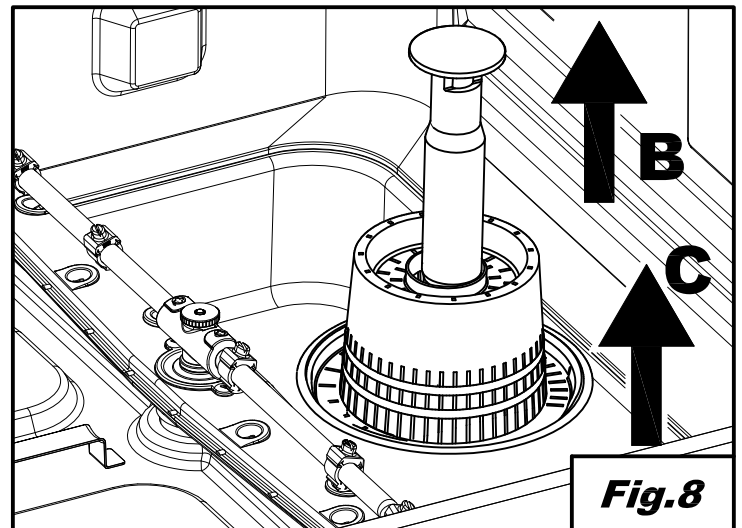

Fig.8

