











	Modell	san+tech 38-33TD	
	Artikelnummer	IT3813SCDSADD	
	Steuerung :		
			
	Äußere Abmessungen (Breite-Tiefe-Höhe) *offen	mm	724 - 818 - 1599(*2080)
	Verpackungsmaße (BxTxH)	mm	760x840x1520
	Bruttogewicht	kg	120
	Nettogewicht	kg	110
	Volumen	m ³	0,98
	Korbgröße	mm	500x500
	Maximale Türöffnung	mm	450
	Maximal nutzbare Höhe	mm	425
	Gehäusekonstruktion		doppelwandig
	Tür/Haubenkonstruktion		doppelwandig
	Tankkonstruktion		tiefgezogen
	Tankvolumen	liter	15
	Tankheizung	W	2.100
	Tankflächensieb		Edelstahl
	Waschpumpentyp		doppelflutig
	Waschpumpenleistung	W	470
	Waschtemperatur	°C	60-->75
	Boilertyp		drucklos
	Boilervolumen	liter	6
	Rückflussverhinderer		freier Auslauf
	Boilerheizung	W	7.000
	Nachspülpumpe		ja
	Nachspülpumpenleistung	W	200
	Nachspültemperatur	°C	67-->90
	Wasserverbrauch der Nachspüllung	Liter /Korb	2,2
	Optimaler externer Wasserdruck	bar	1 - 4
	Ablaufsystem		Teilentleerung
	Ablauffilter		dreifach filterung
	Ablaufpumpe		Standardmäßig eingebaut
	Klarspülmitteldosierer		ja
	Reinigerdosierer		ja
	Sauglanzen		ohne
	Enthärter (Kontinuierlicher Typ)		ja
	Zyklusdauer	Sekunden	90 - 120 - 240
	Sonder-Zyklen	programme	n°5
	Spezieller Thermodesinfektor Zyklus (A0)		ja
	Selbstreinigungszyklus		ja
	Datenaufzeichnung über dedizierten USB-Port	150 Zyklen	ja
	Gesamtanschlußwert	W	9.600
	Stromanschluß	V - ph - Hz	400V 3N 50Hz
	Absicherung	A	16
	Tellerkorb	n° 1	780131
	Gläserkorb	n° 1	780132
	Besteckköcher	n° 1	780139
	Anschlusskabel	n° 1	ja
	Ablaufschlauch	n° 1	ja
	Zulaufschlauch	n° 1	ja

A		Ø 35 mm M	A		Ø 25 mm M
B		G 3/4" M	B		G 3/4" F
C		Power supply			



* LUCE UTILE PER CESTELLO
USEFUL SPACE FOR BASKET
LUMIERE OUTIL POUR PANIER
NUTZBARE OFFNUNG FÜR KORBE
ABERTURA UTIL PARA CESTO

Installation layout		Hood type with drain pump		NH50APS 00	
Designed by:	M.PUCCI	Date:	02.10.2017	Denomination:	
Code:		Rev.:			

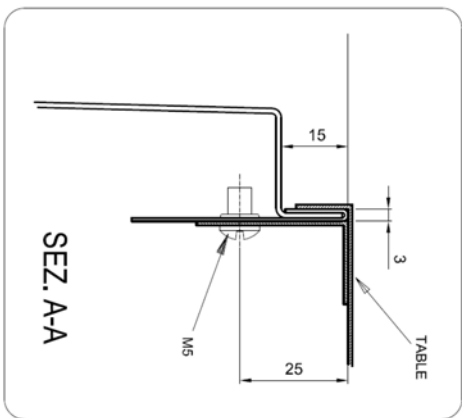
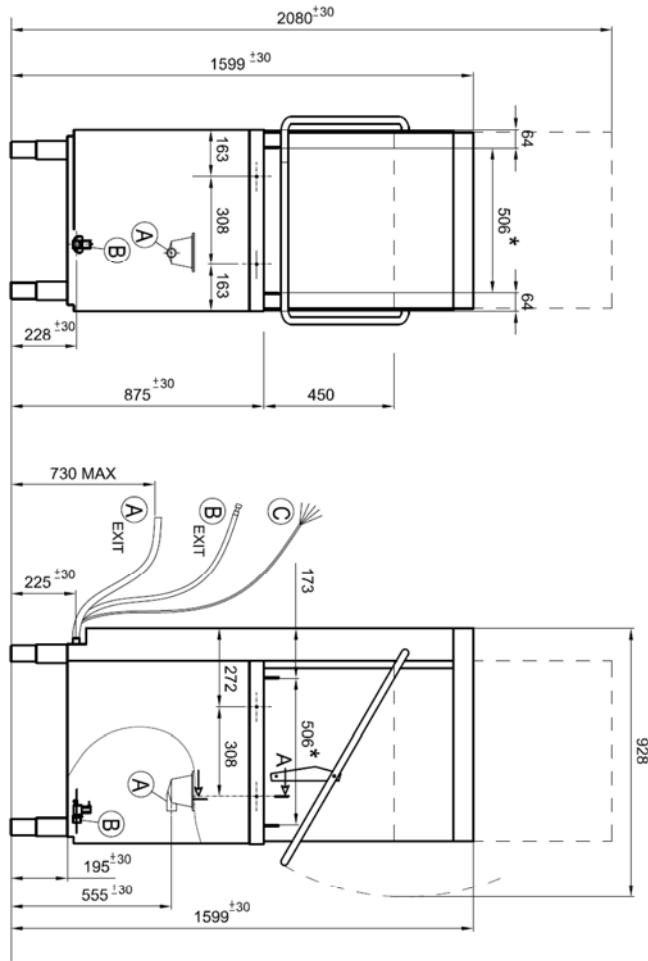
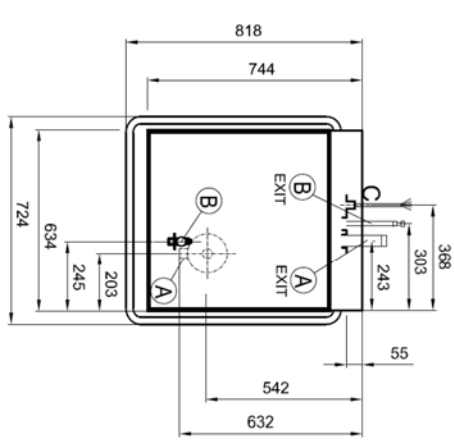