















	Modell	Isy^{tech} 32-11D.4	
	Artikelnummer	LP411CDDD	
	Steuerung:		
			
	Äußere Abmessungen (Breite-Tiefe-Höhe) *offen	mm	719 x 782(*1180)x1727(*1997)
	Verpackungsmaße (BxTxH)	mm	870x890x2200
	Bruttogewicht	Kg	157
	Nettogewicht	Kg	148
	Volumen	mc	1,70
	Korbgröße	mm	560x630
	Maximale Türöffnung	mm	650
	Maximal nutzbare Höhe	mm	600
	Gehäusekonstruktion		doppelwandig
	Tür/Haubenkonstruktion		doppelwandig
	Tankkonstruktion		tiefgezogen
	Tankvolumen	liter	37
	Tankheizung	W	3.000
	Tankflächensieb		Edelstahl
	Waschpumpentyp		doppelflutig
	Waschpumpenleistung	W	1.500
	Waschtemperatur	°C	55 (55-65)
	Boilertyp		druckabhängig
	Boilervolumen	liter	6
	Rückflussverhinderer		ventil
	Boilerheizung	W	6.000
	Nachspülpumpe		ohne
	Nachspülumpenleistung	W	-
	Nachspültemperatur	°C	80 (80-85)
	Wasserverbrauch der Nachspülung	Liter /Korbe	3
	Optimaler externer Wasserdruck	bar	2 - 6
	Ablaufsystem		Tiefenentladung
	Ablauffilter		doppelfilter
	Ablaufpumpe		Standardmäßig eingebaut
	Klarspülmitteldosierer		ja
	Reinigerdosierer		ja
	Sauglanzen		ohne
	Zyklusdauer	Sekunden	120 - 240 - 360 - 720
	Sonder-Zyklen	programme	n°4
	Selbstreinigungszyklus		ja
	Gesamtanschlußwert	W	10.500
	Stromanschluß	V - ph - Hz	400V 3N 50Hz
	Absicherung	A	20
	Korb aus edelstahl	N°1	41305
	Edelstahleibnsatz Für 5 tablettis		YES
	Anschlusskabel		ja
	Ablaufschlauch		ja
	Zulaufschlauch		ja

A		∅ 50mm M	A		∅ 35 mm M
B		G 3/4" M	B		G 3/4" F
C		Power supply	E		Steam exhaust



Installation layout		Utensil washer with Drain Pump	
Designed by:	M.P.F.R.I.	Date:	05.10.2018
Code:	LP4	Rev.:	00

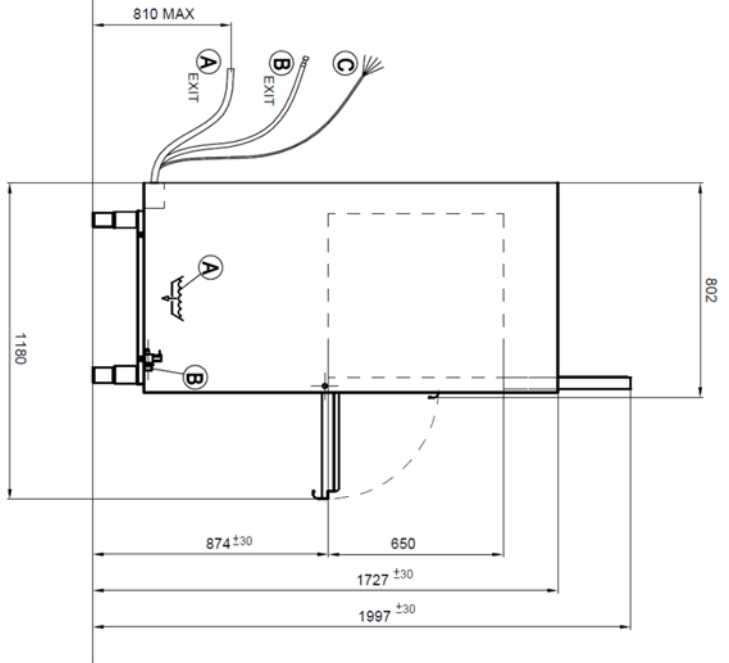
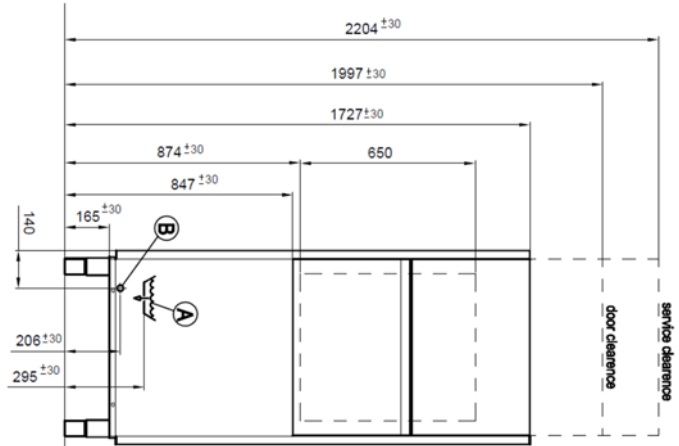
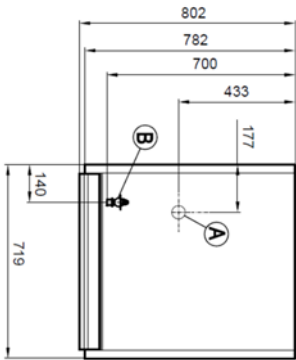