













	Modell	<b>toptech 38-23 GD COP</b>	
	Artikelnummer	TT3823DDCOP**	
Steuerung :			
			
			
			
	Äußere Abmessungen (Breite-Tiefe-Höhe) *offen	mm	721 - 836 - 1565(*2080)
	Verpackungsmaße (BxTxH)	mm	870x760x1540
	Bruttogewicht	kg	120
	Nettogewicht	kg	110
	Volumen	m <sup>3</sup>	1,02
	Korbgröße	mm	500 x 500
	Maximale Türöffnung	mm	465
	Maximal nutzbare Höhe	mm	440
	Gehäusekonstruktion		doppelwandig
	Tür/Haubenkonstruktion		doppelwandig
	Tankkonstruktion		tiefgezogen
	Tankvolumen	Liter	22
	Tankheizung	W	2.500
	Tankflächensieb		edelstahl
	Waschpumpentyp		doppelflutig
	Waschpumpenleistung	W	700
	Waschtemperatur	°C	60 (45-->72)
	Boilertyp		drucklos
	Boilervolumen	Liter	12
	Rückflussverhinderer		freier Auslauf
	Boilerheizung	W	7.000
	Nachspülpumpe		ja
	Nachspülpumpenleistung	W	200
	Nachspültemperatur	°C	80 (60-->88)
	Wasserverbrauch der Nachspülung	Liter /Korb	1,6
	Optimaler externer Wasserdruck	bar	1 - 4
	Ablaufsystem		Teilentleerung
	Ablauffilter		dreifach filterung
	Ablaufpumpe		Standardmäßig eingebaut
	Klarspülmitteldosierer		ja
	Reinigerdosierer		ja
	Sauglanzen	N°2	ja
	Enthärter ( Kontinuierlicher Typ )		ohne
	Zyklusdauer	Sekunden	60 - 90 - 180
	Sonder-Zyklen	programme	n° 8
	Selbstreinigungszyklus		ja
	Gesamtanschlußwert	W	10.200
	Stromanschluß	V - ph - Hz	400V - 3N - 50Hz
	Absicherung	A	16
	Tellerkorb	N° 1	780072
	Gläserkorb	N° 1	780135
	Besteckköcher	N° 1	780146
	Anschlusskabel		ja
	Ablaufschlauch		ja
	Zulaufschlauch		ja

A		∅ 32 mm
B		G 3/4"
C		Power supply



\* LUCE UTILE PER GESTELLO  
USEFUL SPACE FOR BASKET  
LUMIERE UTILE POUR PANIER  
NUTZBARE OFFENUNG FÜR KORBE  
ABERTURA UTIL PARA CESTO

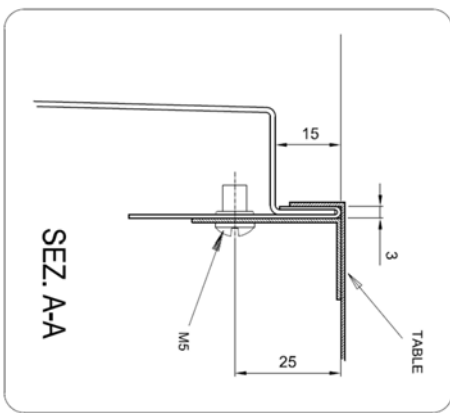
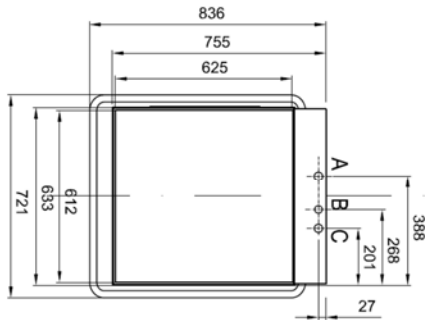
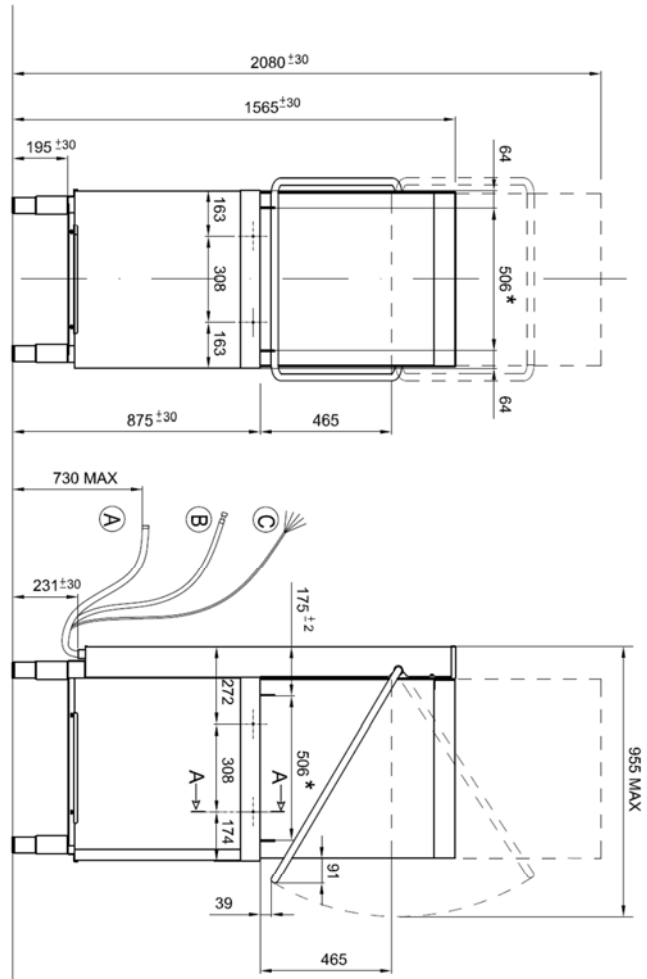

Designed by: M.PUCCI Date: 03.12.2013  
**Installation layout**  
 Hood type with drain pump  
 Code: 73991 Rev.: 01

