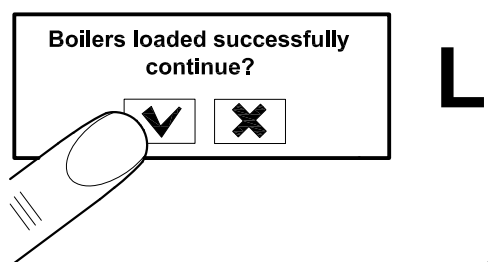
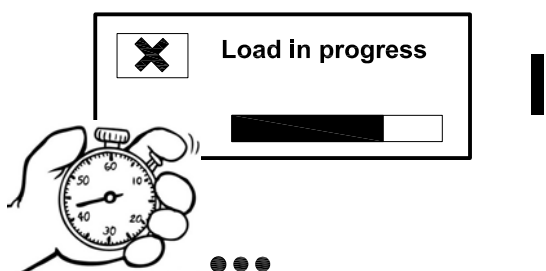
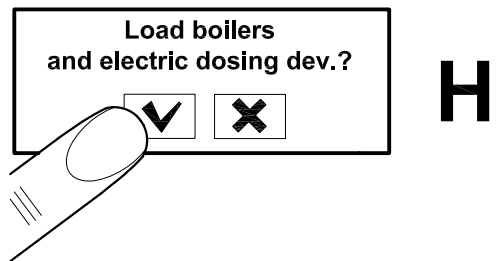
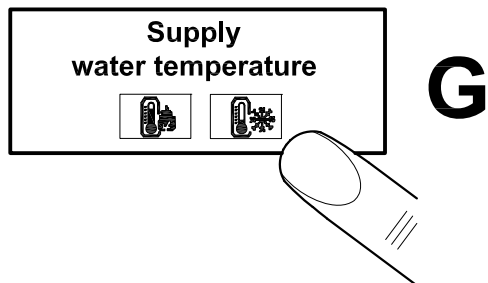
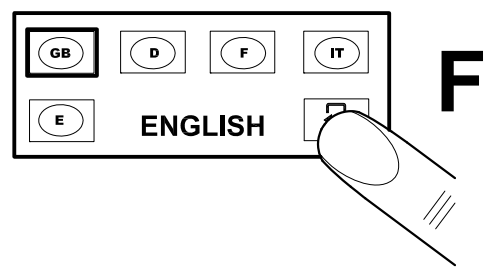
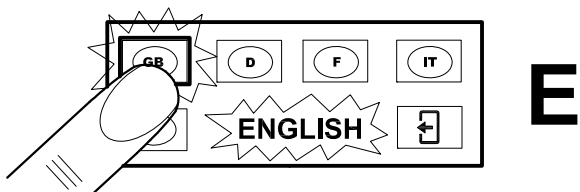
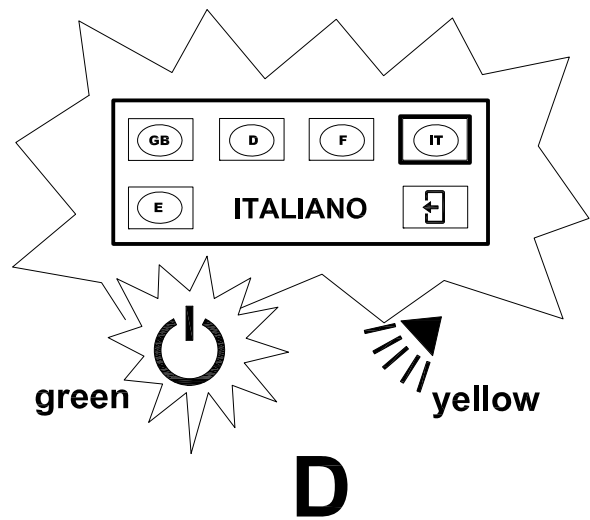
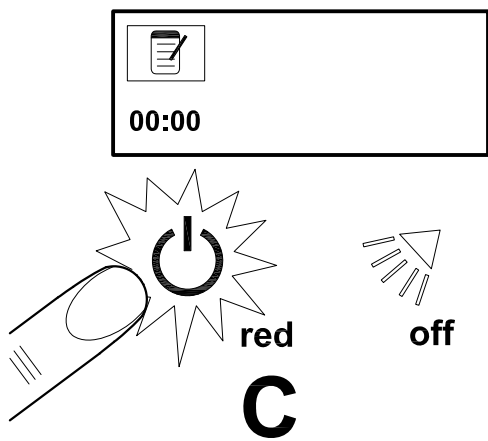
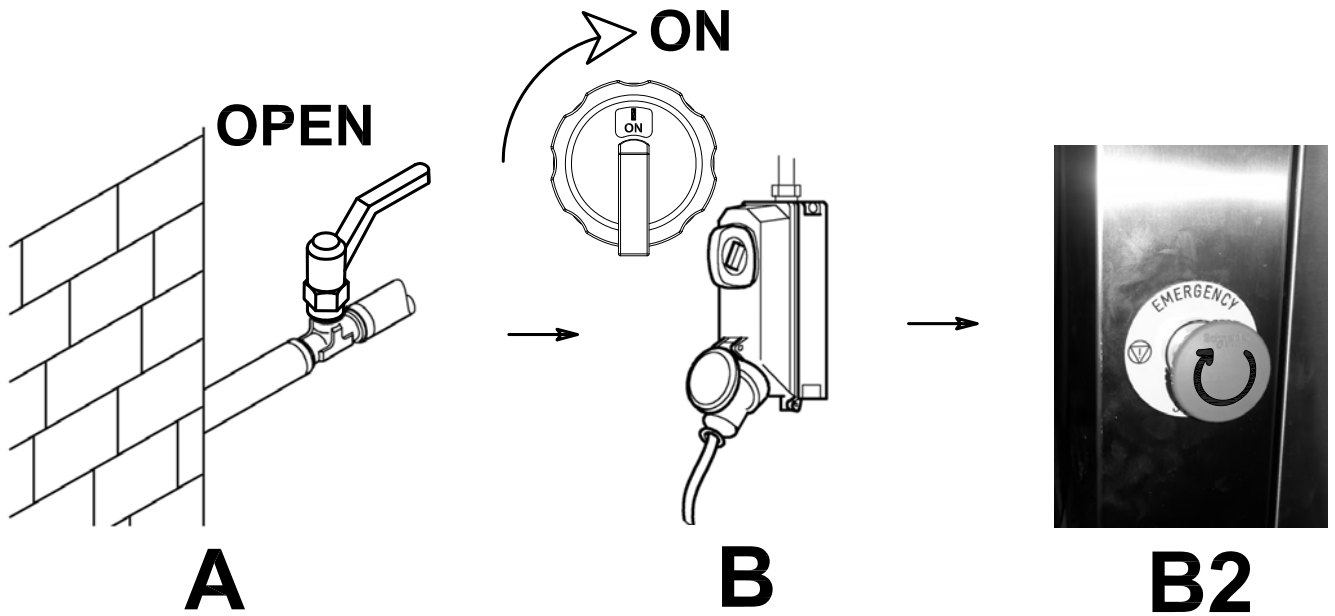



**Fig.1**



**Fig.2**

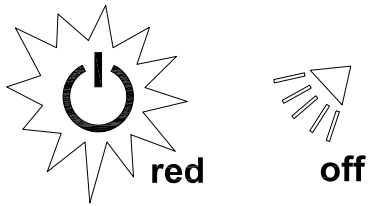

**VERSIONE HW & SW**  
 POW:H-0037\_2 F-150612  
 DIS:H-0038\_2 F-150612  
**00:00**

**A1**

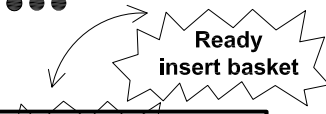

**Wait Please**

**A**



**Pronta premere START**

**B**



**Fig.3**

**Ready insert basket**

**A**

**Ready insert basket**

**B**







**Lavaggio attivo**

**C**





**Fig.4**

**Pronta premere START**

**A**







**B**

**C**

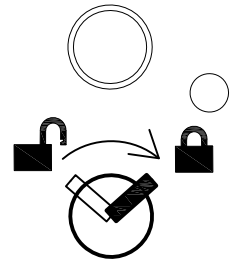
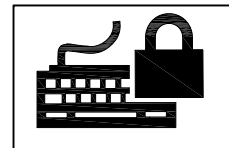
**Fig.5**



**Pronta premere START**

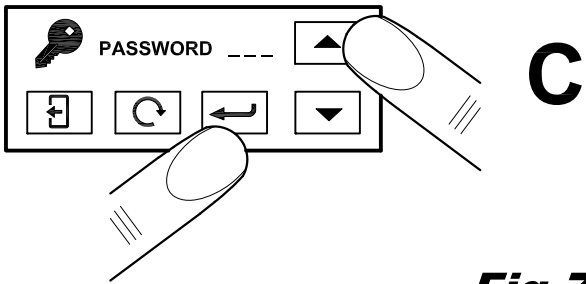
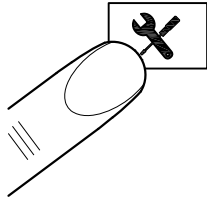
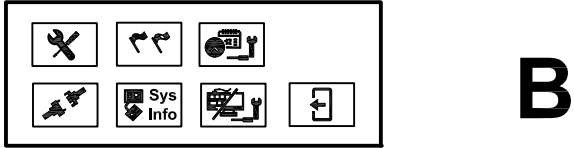
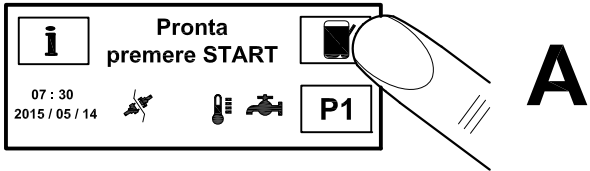

**Fig.5B**

**Lavaggio attivo**



**A**

**Fig.6**

T W2 +50.0°C  
 T B1 +79.1 °C  
 T B2 +80.3 °C

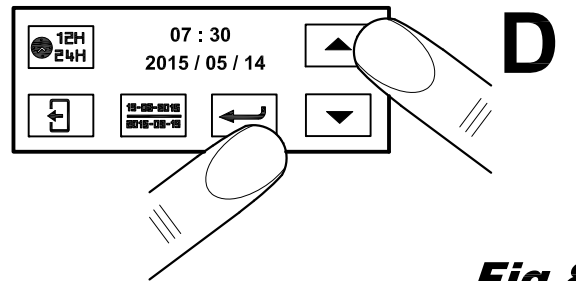
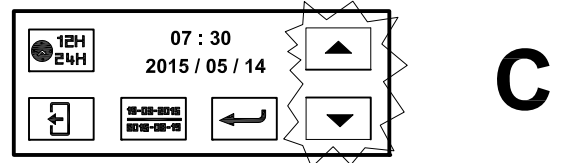
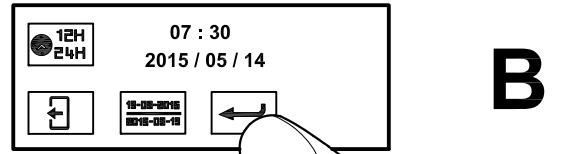
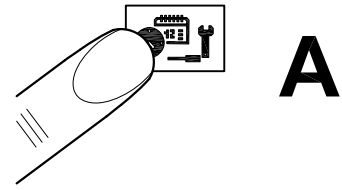

**Fig.7**



**Fig.8**

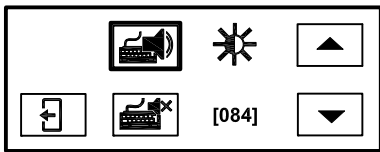
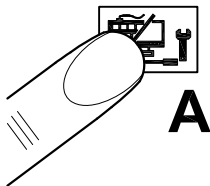

**Fig.9**

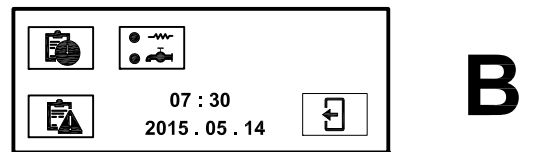

**Fig.10**

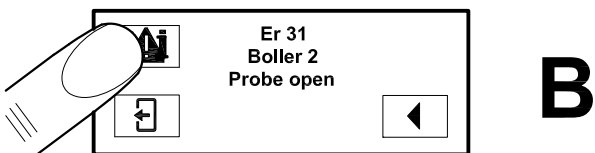
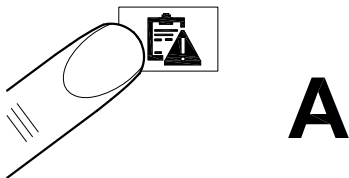

**Fig.11**

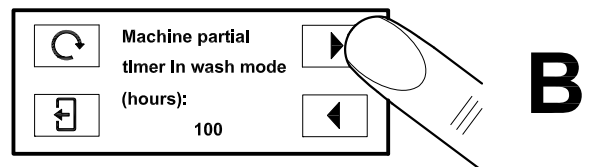
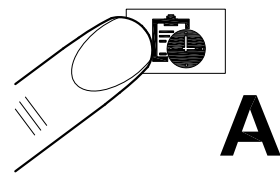

**Fig.12**

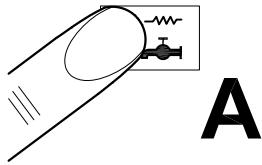

**A**

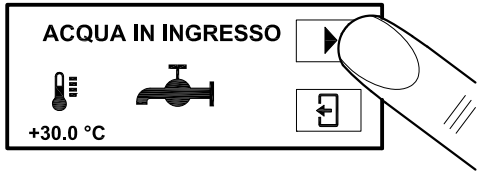

**B**

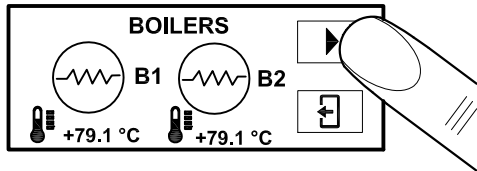

**C**

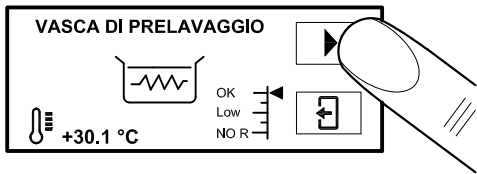

**D**

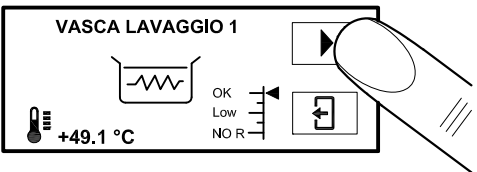

**E**

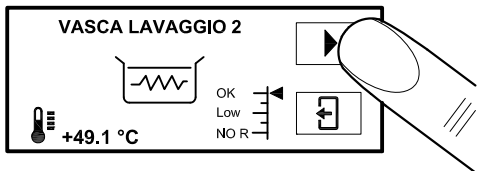

**F**

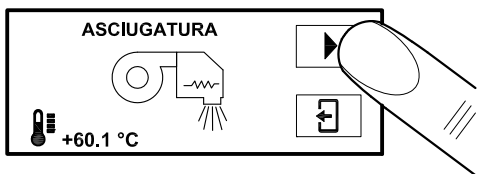

**G**

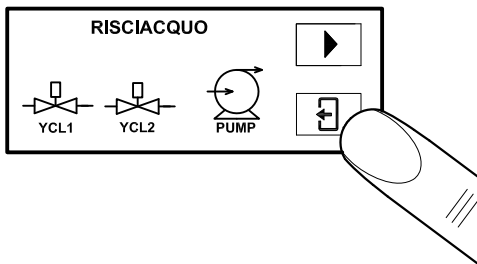

**H**

**Fig.13**

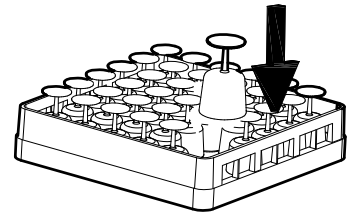
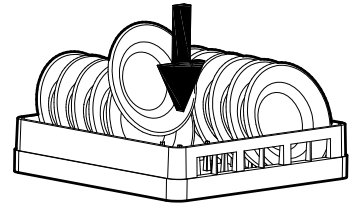

**Fig.14**



**Fig.15**

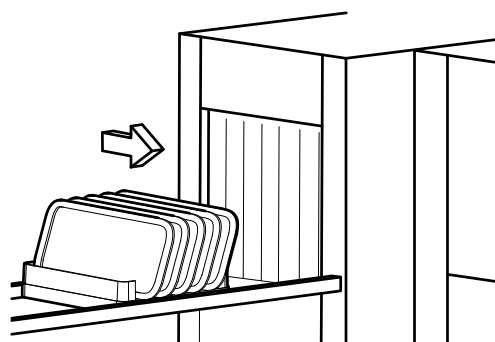

**Fig.16**

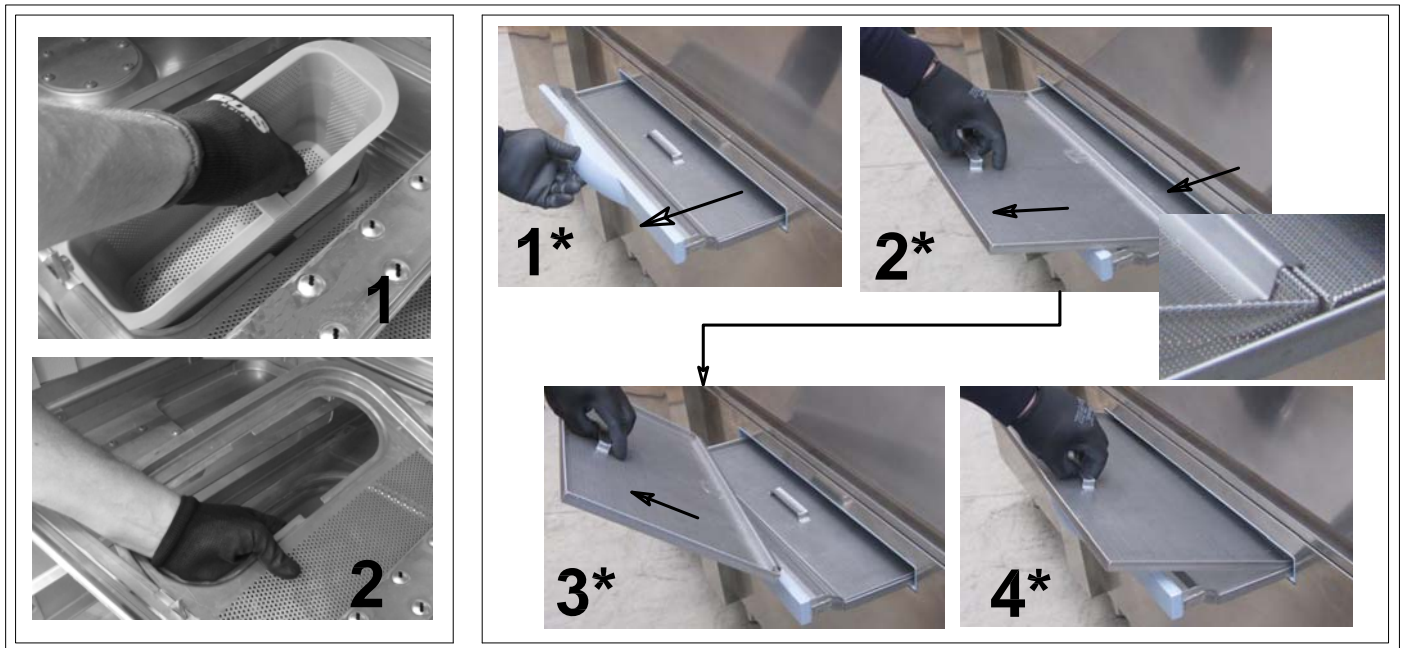
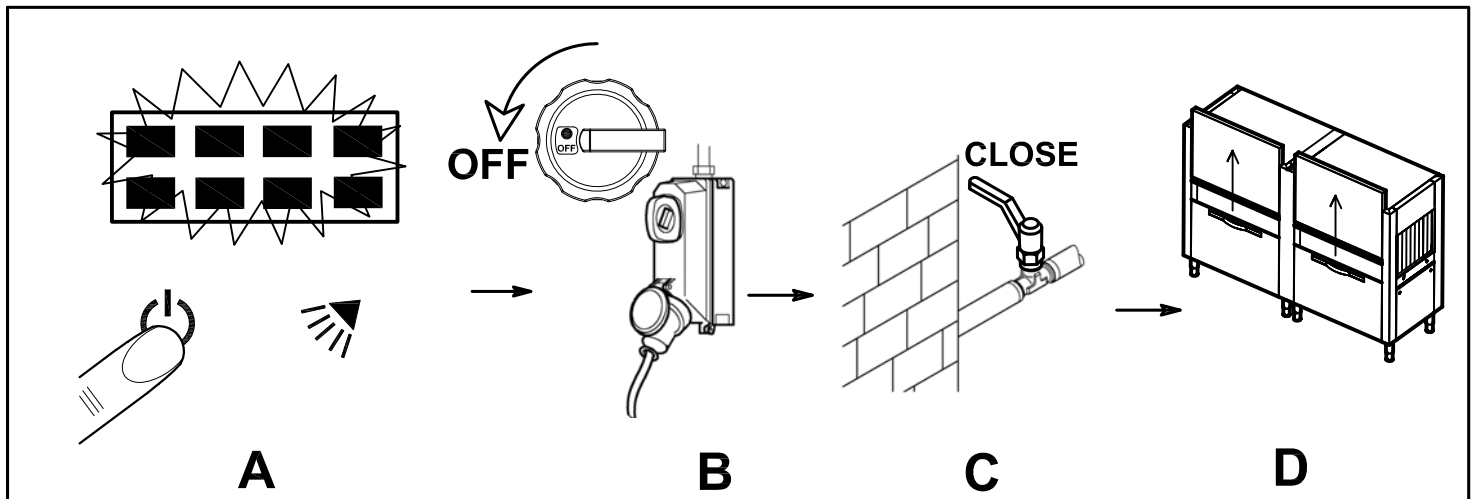

**E**



**F**

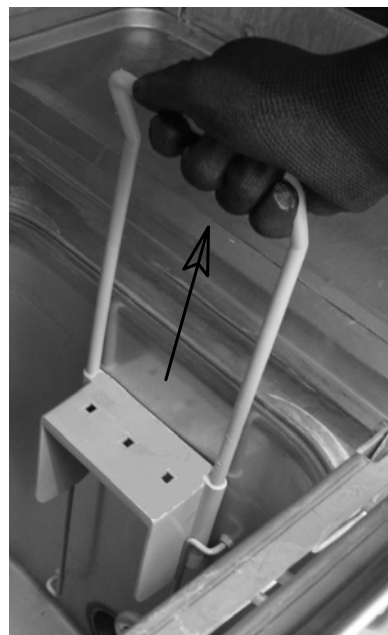

**G**

**Fig.17**

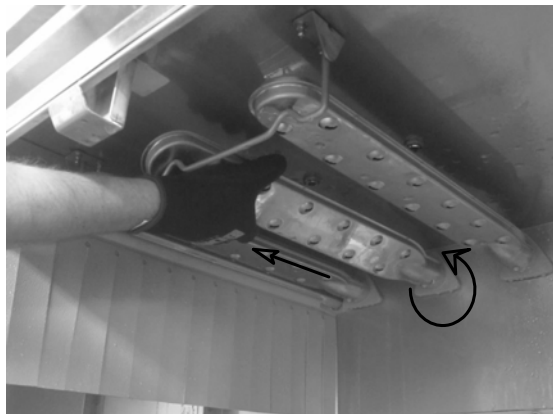
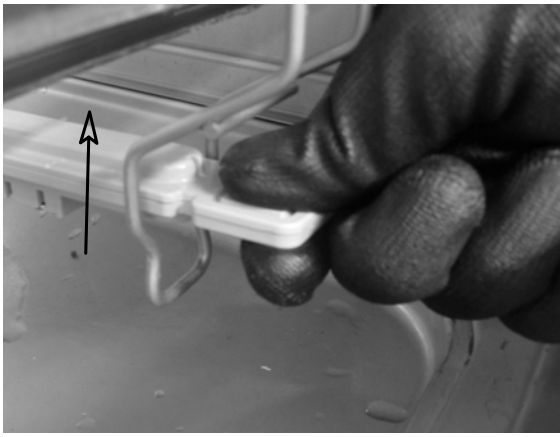

**Fig.18**

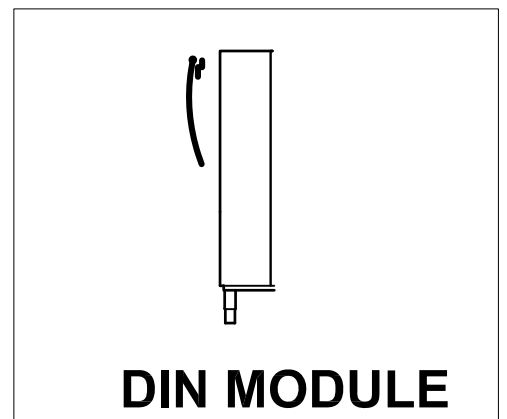
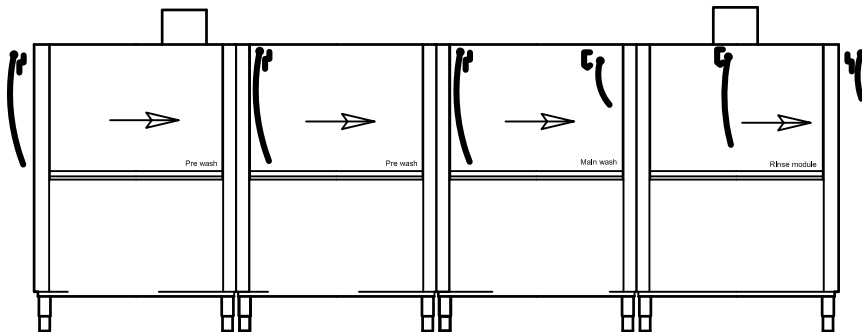
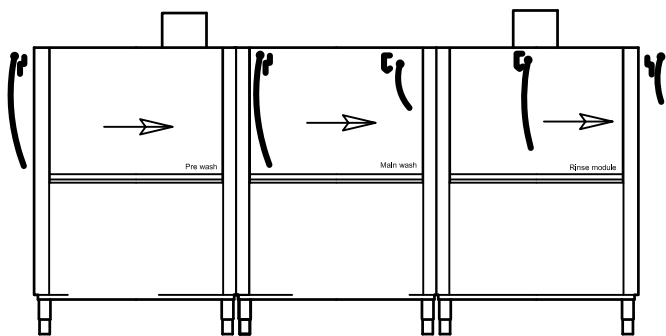
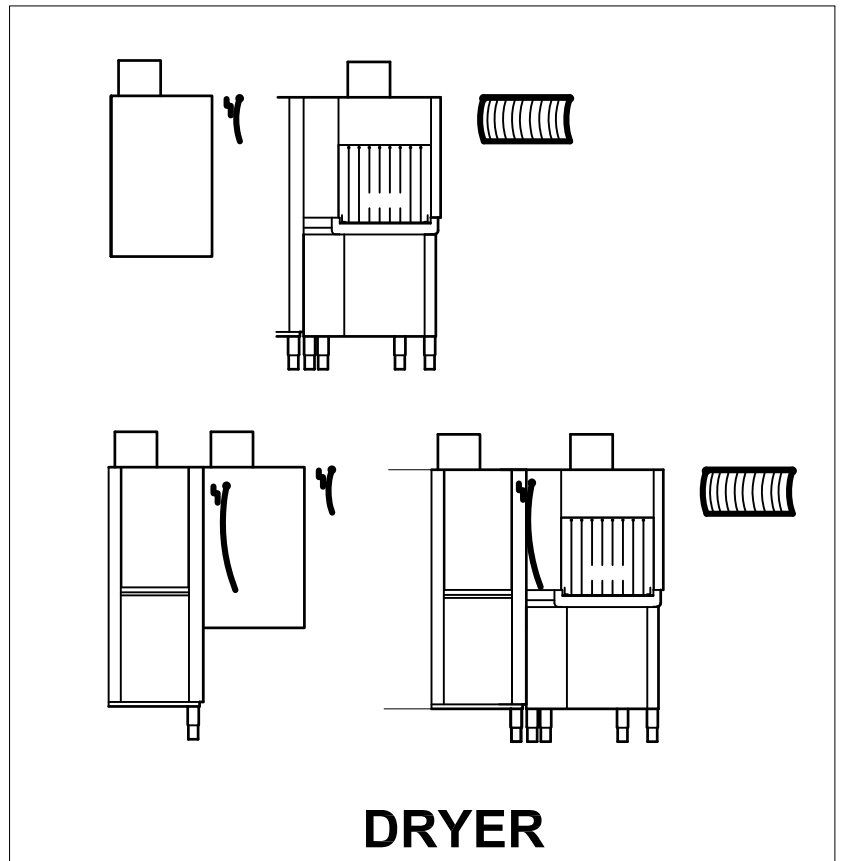
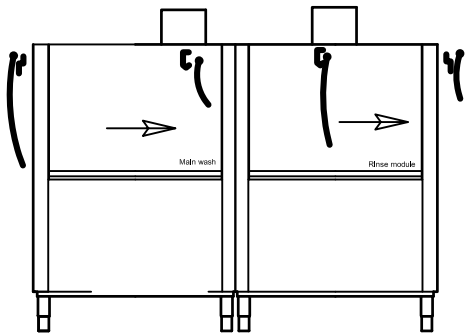

**Fig.19**